

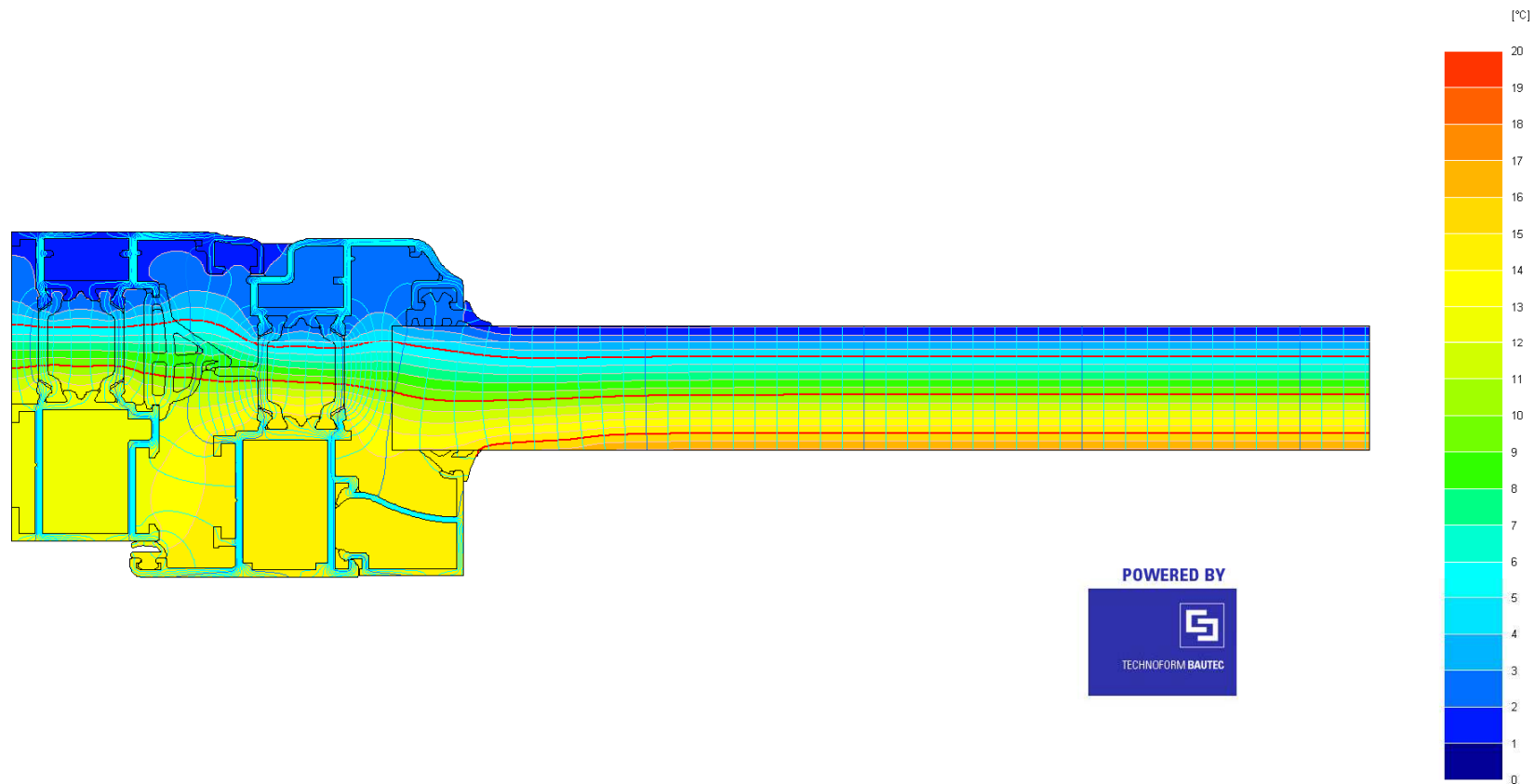

Thermal performance

■ 65T



$$U_f = 2.86 \text{ W/m}^2\text{K}$$